



## BERNSTEIN CC-5000 *next* Aluminium Control Enclosure

Protection in its most beautiful form

## The new Aluminium Control Enclosure CC-5000

Design aspects along with **modularity**, **functionality** and **ergonomics**, are rapidly becoming more and more important for plant and machinery manufacturers, especially when selecting the appropriate control enclosure for their machines and installations. To meet the increasing demand for aesthetically pleasing enclosures, we have developed a new BERNSTEIN Control Enclosure System.

In addition to technical optimisation, **contemporary design** and a **modular system** is of the utmost importance – all of which are included in this new product.

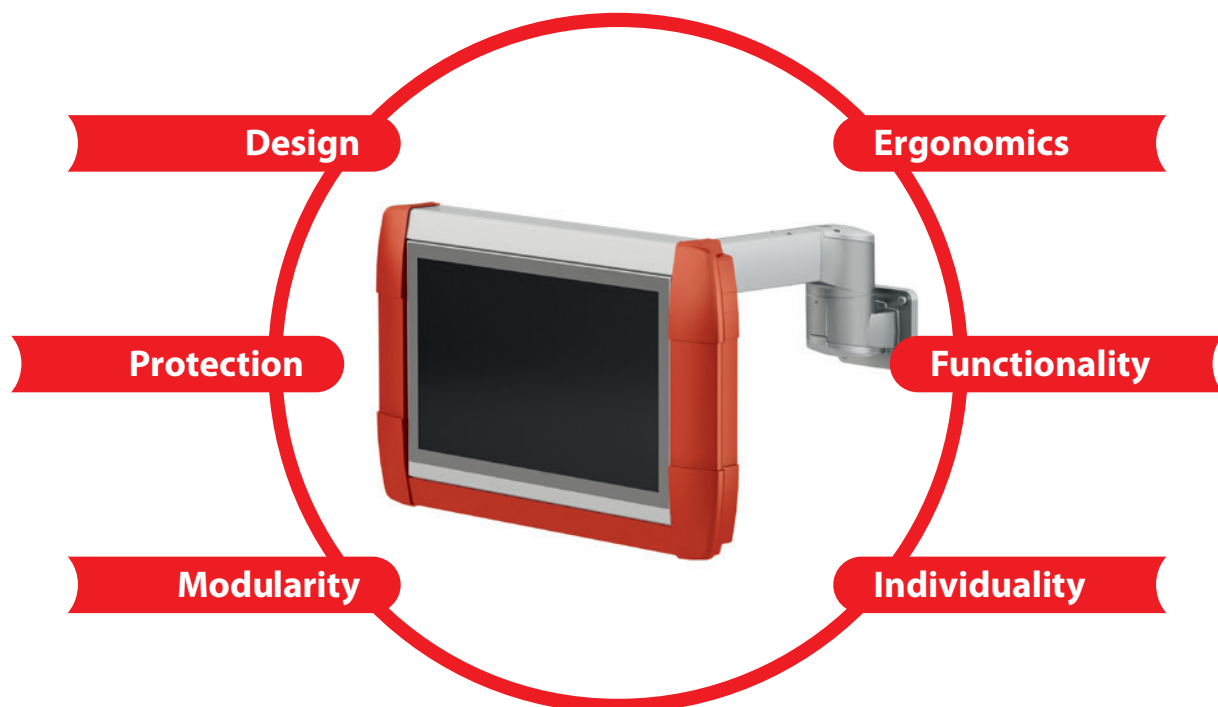

### Product features

- Modern and functional industrial design
- High-quality extruded aluminium sections (naturally anodised)
- Customised colours from RAL range
- Single-walled sections that provide outstanding heat dissipation
- Integrated recessed grips for simple handling
- Protection class IP 65
- All-round mounting grooves for built-in components, no need for modifications
- Internally mounted front panel
- Door configurations for direct access to the interior
- Slimline design for configuring flat screen systems
- Customised solutions to your specifications (see checklists on pages 12-15)

## Individual colour combination

You are even able to personalise the colour of the enclosure to your specific corporate identity.



Corner modules, front and rear panels, as well as the standard version anodised aluminium sections can all be optionally powder-coated to a wide variety of RAL colours – giving the enclosure a unique and individual touch.

- Monochrome
- Coloured end caps, anodised sections
- Coloured side handle sections and end caps
- Coloured horizontal sections and end caps
- Coloured frames

## Modular system



### Control Enclosure versions

The dimensions of the new control enclosure CC-5000 neXt (along with our existing series CC-3000, CC-4000 and CC-4000 SL) are freely selectable. Nine possible depths are available. The obtained installation depths range from 2.1" to 13.1" The width and height dimensions are offered up to **39.4"** in either direction.

Frames can be used in individual or multiple combinations.

Innovative console configurations are possible thanks to a connecting element which has been designed in line with the new design.

### Front panel

- Internally-mounted front panel through clamping tie bar
- Machining for integrating IPCs or Panel-PCs, push buttons and interfaces or engravings on demand
- Screen print according to your specifications on demand

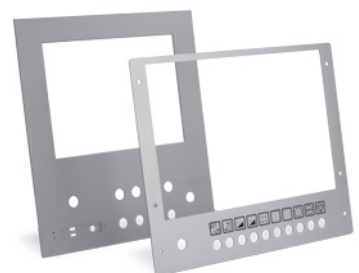

## Console version



**Individual solutions  
for operating  
and monitoring**

### System features

For console versions, the keyboard is located in a separate housing. The specially designed coupling head connects the control panel (upper part) to the keyboard console (lower part).

The keyboard console can be mounted inclined downwards by 20 or 10 degrees. In the first case, the control panel is perpendicular, whilst in the second case it is inclined backwards by 10 degrees.

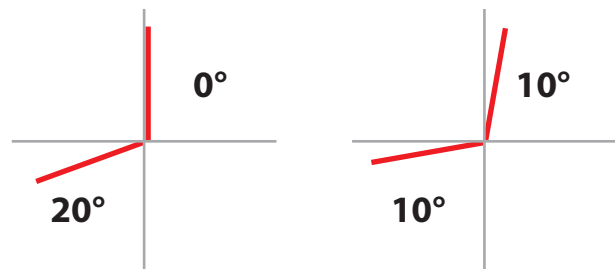

## Technical details

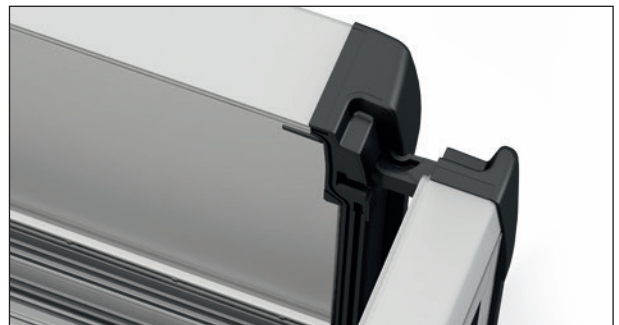

### Frame design

- Use of **extruded aluminium sections** (standard naturally anodised)
- Assembling of section via **corner modules**

### Hinge

- New **concealed hinge design**
- Hinge is unseen when door is closed
- **Unique** in the market today



## Door centring









- Door centred via **alignment feature**
- **Invisible** in closed position
- **Secure** door closing

## Rear panel

- **Fixed** version  
(optional connection to panel coupling)
- **Hinged** version

## Sections and combination possibilities

To provide simple and safe handling when connecting to the suspension system, the CC-5000 neXt has integrated recessed grips on the left and right hand side. Inside there are adjustable slots to allow components such as power supply units, support panels, terminal mounting rails etc. to be easily attached.

Basis sections	External depth	Installation depth
	3"	2.1"
	4.9"	4.1"
	7.3"	6.4"
Section combinations	External depth	Installation depth
	6" (3" + 3")	4.5"
	7.9" (3" + 4.9" or 4.9" + 3")	6.5"
	9.8" (4.9" + 4.9")	8.4"
	10.3" (3" + 7.3" or 7.3" + 3")	8.8"
	12.2" (4.9" + 7.3" or 7.3" + 4.9")	10.8"
	14.6" (7.3" + 7.3")	13.2"



## Profile cross sections

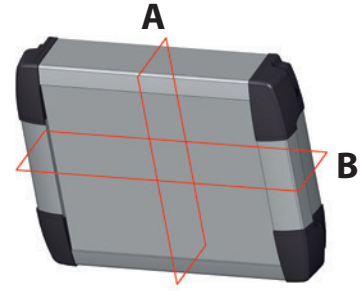

Section	Horizontal sections A	Handle sections B
3"		
4.9"		
7.3"		

## Technical data

### Material

- Extruded sections: Aluminium
- Die-cast corners: Aluminium
- Die-cast caps: Aluminium
- Sealings between section and corner module: PUR
- Sealings for front panel and rear panel: EPDM, PUR and PVC
- Hinge (for section combinations): Aluminium
- Articulated hinge (for enclosure with single sections): Aluminium
- Front panel, rear panel: Aluminium

### Colour

- Sections: Naturally anodised (standard)
- Front panel, rear panel: Naturally anodised (standard)
- Corner modules: RAL 9006, white aluminium (standard)
- All components can be optionally powder-coated to a wide variety of RAL colours

### Protection class

- IP 65

### Operating temperature

- -30 °C to +80 °C (-22 °F to +176 °F)

### Dimensions

- Width x height maximum: 39.4" x 39.4"
- Width x height minimum: 10.9" x 14.8"

### Approvals

- cULus (projected)

## Accessories

Thanks to a comprehensive range of accessories, the modular control enclosure concept can be perfectly adapted to your requirements.



**Optional accessories  
for individual solutions**

- Signal light integrated in the design (RGB-LED)
- Door arrester
- Suspension system components for attaching on the top, bottom and back
- Different keyboard solutions
- Diverse add-on elements (interfaces, push buttons, fans, handles etc.)

**For further control enclosure  
accessories, please see our main  
catalogue**

Customer:	Customer No.: *	Article No.: *
Address:		
Telephone:	E-mail:	
Contact person:	Department:	
<input type="checkbox"/> Pricing enquiry	Target price:	Quantity:
<input type="checkbox"/> Enquiry	Enquiry No.: *	Annual requirement:
<input type="checkbox"/> Order	KPA: *	Delivery date:

### 1 Checklist for:

- Standard
- Console encl., upper part
- Console encl., lower part

▶ please fill in checklist for console versions

Adjustment

Anticipated installation weight: \_\_\_\_\_ kg

### 2 Dimensions (mm)

Installation area (X x Y) \_\_\_\_\_ X \_\_\_\_\_

Enclosure dimensions (W x H) \_\_\_\_\_ X \_\_\_\_\_  
 = X + 152 / 6" fi / Y + 91 / 3 1/2" fi

Front panel dimensions (e x f) \_\_\_\_\_ X \_\_\_\_\_  
 with airflow humidity of 0.5 mm  
 = X + 20 / 3/8" + fi / Y + 21 / 7/8" fi

Rear panel dimensions b x h \_\_\_\_\_ X \_\_\_\_\_  
 with airflow humidity of 1 mm  
 = X + 107 / 4 1/4" fi / Y + 78 / 3 1/8" fi

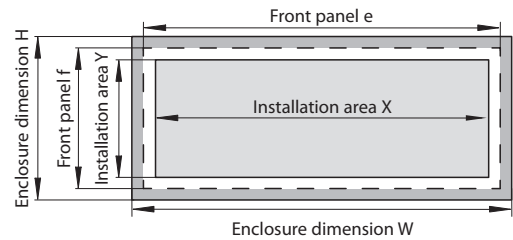

External dimensions min. 277 x 377 mm, max. 1000 x 1000 mm (W x H)

### 3 Profile selection

Select 1 enclosure section (optional, add up to a maximum of 1 door section!)

External depth 0 mm	Front door	Enclosure section (fixed area!)			Rear door
Choice of desired external depth AT	75 (3")				75 (3")
	125 (4.9")				125 (4.9")
	185 (7.3")				185 (7.3")

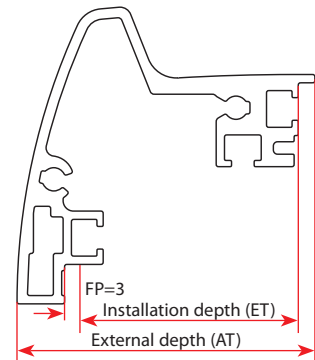

Information about section depth dimensions									
Installation depth ET (mm)	53	103	114	163	164	214	224	274	334
External depth AT (mm)	75	125	150	185	200	250	260	310	370
Basis section	75 / 3" fi	75 (3")		75+75 (3"+3")		75+125 (3"+4.9")			
	125 / 4.9" fi		125 (4.9")				125+125 (4.9+4.9)		
	185 / 7.3" fi			185 (7.3")			185+75 (7.3"+3")	185+125 (7.3+4.9)	185+185 (7.3+7.3)

Section combination: Hinges with BERNSTEIN logo (Ø 20 mm)

### 4 Door mounting

left or  right

### 5 Lock

Square (mm):  6  7  8  T-handle without lock\*\*

Triangle (mm):  7  8  6,5 (CNOMO)  T-handle with lock\*\*

Two-way bit (mm):  3 Standard  5  E1 (without key)

Daimler Benz:   T-handle E1 (without key)\*\*

Special lock \_\_\_\_\_ (\*\* = not for 75 section)

## 6 Front panel *Internally mounted*

- none
- mounted
- Front panel mounting kit

## Rear panel

### Enclosure with door section

- none
- mounted

## Rear panel

### Enclosure without door section

- Standard hinge (with BERNSTEIN logo)
- screw-mounted (externally)
- VESA attachment to the rear

*(screw-fixed rear panel); (rear panel thickness of 4 mm, possible at an installation area height of Y > 500 mm)*

## 7 Partition

- not mounted
  - vertical Qty: \_\_\_\_\_
  - horizontal Qty: \_\_\_\_\_
- Partition height 28 mm.  
 Leave 1 mm space between front panel and partition.  
 Partition protrudes 3.7 mm beyond the front panel.

## Operator panel

- 1<sup>st</sup> Operator panel (w x h) \_\_\_\_\_ x \_\_\_\_\_  not mounted  
 2<sup>nd</sup> Operator panel (w x h) \_\_\_\_\_ x \_\_\_\_\_  mounted  
 3<sup>rd</sup> Operator panel (w x h) \_\_\_\_\_ x \_\_\_\_\_

## 8 Keyboard drawer (at 155 mm installation depth) (interlock via magnetic lock)

- without keyboard, 0°, Height 89 mm (3.5")
- without keyboard, 20°, Height 134 mm (5.3")
- with keyboard, 0°, USB, Height 89 mm (3.5")
- with keyboard, 20°, USB, Height 134 mm (5.3")
- to customer specification (description under 11)
- secured via lock (optional)

- none

### Keyboard configuration

- German (Standard)
- English (GB)
- English (USA)
- Other language: \_\_\_\_\_

## 9 Preparation for susp. system

	Com- ponent selection	75 (3")	125 (4.9")	185 (7.3")
CS-3000 neXt adapter small	<input type="checkbox"/>			
Flange coupling standard*	<input type="checkbox"/>			
Flange coupling system 80	<input type="checkbox"/>			
Turn/tilt coupling	<input type="checkbox"/>			
Tilt adapter	<input type="checkbox"/>			
CS-2000 SL base coupling	<input type="checkbox"/>			
Coupling head	<input type="checkbox"/>			
Coupling head, single	<input type="checkbox"/>			
Automotive adapter	<input type="checkbox"/>			
WS coupling	<input type="checkbox"/>			
CS-3000/48	<input type="checkbox"/>			
VESA-100 (Rear panel attachment)	<input type="checkbox"/>			
Preparation on customer request (see below)	<input type="checkbox"/>			

### Entry/support position

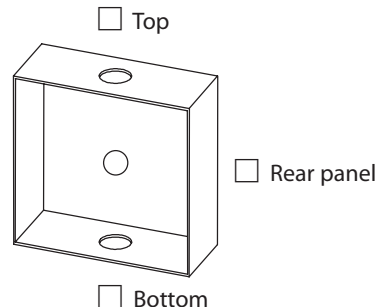

- no preparation
  - SS cover, top
  - SS cover, bottom
- = Component not possible
- \* CS-3000 neXt / CS-3000 / CS-2000 SL/50/60  
 \*\* CS-3000 neXt/ CS-3000 with adapter (narrow sect. 1015300011)

## 10 Surface finish

### Standard

- Horizontal sections  anodised, natural
- Vertical sections  anodised, natural
- Corner modules  RAL 9006 Standard
- Front panel  anodised, natural
- Rear panel  anodised, natural
- Partition  anodised, natural

### Special colour RAL (see page 15)

- \_\_\_\_\_
- \_\_\_\_\_
- \_\_\_\_\_
- \_\_\_\_\_
- \_\_\_\_\_
- \_\_\_\_\_

## 11 Accessories, Remarks

<input type="checkbox"/> Annexes number of _____	VKF*	TA*	AV*	
<input type="checkbox"/> No Annexes				

\* Completed by BERNSTEIN

### 1 Checklist for:

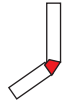

Console attachment

Article No. Console Enclosure, upper part \* \_\_\_\_\_

Article No. Console Enclosure, lower part \* \_\_\_\_\_

### 2 Type of console connection Only one choice is possible

Console connector section	Console connector	Console coupling
<input type="checkbox"/>	<input type="checkbox"/>	<input type="checkbox"/>
<input type="checkbox"/>	<input type="checkbox"/>	<input type="checkbox"/>
<input type="checkbox"/>		

### 3 Preparation for suspension system in the console connector section \*

Only one choice is possible

- preparation
- no preparation
- = Component not possible

	CS-2000 SL45/60, CS-3000, CS-3000 neXt	CS-2000 Sys80
Coupling or Elbow coupling	<input type="checkbox"/>	
New adapter flange (Automotive)		

### 4 Surface finish

- Console connector section NEW (section)  anodised, natural
- Console connector section NEW (end caps)  RAL 9006 Standard
- Console connector  RAL 9006 Standard
- Console coupling  RAL 9006 Standard

#### Special colour RAL (see page 15)

- \_\_\_\_\_
- \_\_\_\_\_
- \_\_\_\_\_
- \_\_\_\_\_

### 5 Accessories, Remarks

<input type="checkbox"/> Annexes number of _____	VKF*	TA*	AV*	
<input type="checkbox"/> No Annexes				

Please note: The colour samples may differ slightly from the original colour. Other colours on request.

RAL number	Colour sample	Designation
RAL 1013		Oyster white
RAL 1015		Light ivory
RAL 1019		Grey beige
RAL 3000		Flame red
RAL 3002		Carmine red
RAL 3003		Ruby red
RAL 3004		Purple red
RAL 3005		Wine red
RAL 3011		Brown red
RAL 3013		Tomato red
RAL 3020		Traffic red
RAL 5002		Ultramarine blue
RAL 5003		Sapphire blue
RAL 5005		Signal blue
RAL 5007		Brilliant blue
RAL 5008		Grey blue
RAL 5009		Azure blue
RAL 5010		Gentian blue
RAL 5011		Steel blue
RAL 5012		Light blue
RAL 5013		Cobalt blue
RAL 5014		Pigeon blue
RAL 5015		Sky blue
RAL 5023		Distant blue
RAL 5024		Pastel blue
RAL 6001		Emerald green
RAL 6002		Leaf green
RAL 6003		Olive green
RAL 6004		Blue green
RAL 6005		Moss green
RAL 6007		Bottle green
RAL 6009		Fir green
RAL 6011		Reseda green
RAL 6012		Black green
RAL 6019		White green
RAL 6021		Pale green
RAL 6028		Pine green
RAL 6034		Pastel turquoise
RAL 7000		Squirrel grey
RAL 7001		Silver grey
RAL 7004		Signal grey
RAL 7006		Beige grey
RAL 7011		Iron grey
RAL 7012		Basalt grey
RAL 7015		Slate grey

RAL number	Colour sample	Designation
RAL 7016		Anthracite grey
RAL 7021		Black grey
RAL 7022		Umbra grey
RAL 7024		Graphite grey
RAL 7030		Stone grey
RAL 7031		Blue grey
RAL 7032		Pebble grey
RAL 7033		Cement grey
RAL 7035		Light grey
RAL 7036		Platina grey
RAL 7037		Dusty grey
RAL 7038		Agate grey
RAL 7039		Quartz grey
RAL 7040		Window grey
RAL 7042		Traffic grey A
RAL 7043		Traffic grey B
RAL 7044		Silk grey
RAL 7045		Telegrey 1
RAL 7046		Telegrey 2
RAL 7047		Telegrey 4
RAL 8001		Ochre brown
RAL 8002		Signal brown
RAL 8003		Clay brown
RAL 8007		Fawn brown
RAL 8011		Nut brown
RAL 8012		Red brown
RAL 8014		Sepia brown
RAL 8015		Chestnut brown
RAL 8016		Mahogany brown
RAL 8017		Chocolate brown
RAL 8019		Grey brown
RAL 8022		Black brown
RAL 8023		Orange brown
RAL 8025		Pale brown
RAL 8028		Terra brown
RAL 9001		Cream
RAL 9002		Grey white
RAL 9003		Signal white
RAL 9004		Signal black
RAL 9005		Jet black
RAL 9006		White aluminium
RAL 9007		Grey aluminium
RAL 9010		Pure white
RAL 9011		Graphite black
RAL 9016		Traffic white
RAL 9018		Papyrus white



**Switch systems –  
Economy meets safety**



**Sensor systems –  
Compact intelligence**



**Enclosures systems –  
Function and design**

[www.altechcorp.com](http://www.altechcorp.com)